

MIPOT NETWORK LONG RANGE TRX MODULE

Product Code: **32001345M**



PRODUCT SUMMARY:

The 32001345M is a **Lora™ technology-based** transceiver operating in the 868 MHz SRD band, optimized for **ultra-long range, low consumption applications**, suitable for **low power networks**.

In addition to its unparalleled range, spread spectrum modulation assures great immunity to interferers.

A proprietary stack makes this module an **RF modem**, allowing to implement from **point-to-point communication** to more complex custom networks (provided that the network protocol is managed from the outside).

Small LCC form factor (15.5 x 26 mm only) and **ultra-low current consumption**, this module is ideal for the implementation of highly integrated low power (battery operated) solutions for Internet of Things (IoT) applications, security systems, alarms, sensor networks, metering, smart buildings, agriculture, supply chain.

All messages are cyphered with **AES128 encryption algorithm** ensuring confidential authentication and integrity during the exchanging of data payload.

The module meets all the requirements in the **industrial temperature range -40/ 85 °C**.

Developed according to **ETSI EN 300 220** European Standard.

The module meets with the Radio Equipment Directive (**RED**) 2014/53/EU.

Compliant with **REACH** and **RoHS** directives.



MECHANICAL CHARACTERISTICS

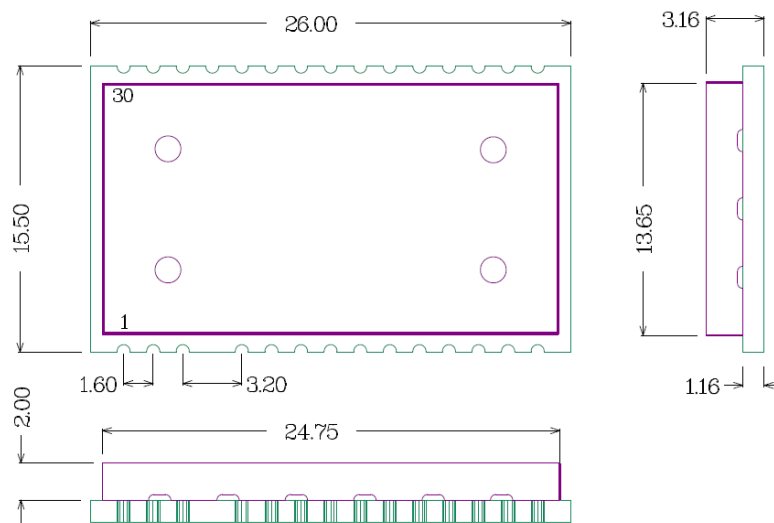

ALL DIMENSIONS ARE IN MILLIMETERS
GENERAL TOLERANCE +/-0.1MM

MIPOT S.P.A.

Via Corona, n.5

(Zona Ind.)

34071 Cormons (GO)

Italy

Tel.+39 0481 630200 ra.

Fax +39 0481 62387

mipot@mipot.com

PIN DESCRIPTION

Pin	Name	Pin Type	Description	Notes
1	GND	Power Supply	Ground (0 V)	
2	RF I/O	A IN/OUT	Tx: output RF / Rx: input RF	3
3	GND	Power Supply	Ground (0 V)	
5	NU	NC	Not Used Pin – do not connect	
6	NDATA_INDICATE	Data OUT	Data Indicate Pin	
7	NWAKE	D IN	Wake-up Pin	
8	NU	NC	Not Used Pin – do not connect	
9	NU	NC	Not Used Pin – do not connect	
10	NU	NC	Not Used Pin – do not connect	
11	UART TX	D OUT	UART TX Pin	
12	UART RX	D IN	UART RX Pin	
13	NU	NC	Not Used Pin – do not connect	
14	NU	NC	Not Used Pin – do not connect	
15	GND	Supply	Ground (0 V)	
16	GND	Supply	Ground (0 V)	
17	Vcc	Supply	Power supply	
18	SWDAT	NC	Reserved for programming – do not connect	
19	SWCLK	NC	Reserved for programming – do not connect	
20	SWV	NC	Reserved for programming – do not connect	
21	NRST	D IN	Reset. Input Pull-Up	
22	NU	NC	Not Used Pin – do not connect	
23	NU	NC	Not Used Pin – do not connect	
24	NU	NC	Not Used Pin – do not connect	
25	NU	NC	Not Used Pin – do not connect	
26	NU	NC	Not Used Pin – do not connect	
27	NU	NC	Not Used Pin – do not connect	
28	NU	NC	Not Used Pin – do not connect	
29	NU	NC	Not Used Pin – do not connect	
30	GND	Supply	Ground (0 V)	

ABSOLUTE MAXIMUM RATINGS

Transceiver Power Supply Vcc (pin 15)	-0.3 ÷ 3.8 V
Max. Voltage allowed on input pins	Vcc + 0.3 V
Storage Temperature (excl. package)	-40 ÷ 85 °C
Storage Temperature (incl. package)	-10 ÷ 65 °C
Operating Temperature	-40 ÷ 85 °C
Radio Frequency Input, pin 2:	10 dBm

ELECTRICAL CHARACTERISTICS @ 25°C TEMPERATURE

Parameter	Min.	Typ.	Max.	Unit	Notes
Supply Voltage (Vcc)	2.1	3.0	3.7	V	
Current drain Sleep	-	1.2	-	µA	1
Current drain Tx mode	-	70	-	mA	1
Current drain Rx	-	17	-	mA	1
Operating frequency range	868.075	-	869.925	MHz	2
Tx frequency accuracy	-	±10	-	kHz	2
Sensitivity	-	-	-124	dBm	2
Output Power (on 50 Ω load)	-	14	-	dBm	2
Modulation	LoRa				
UART Interface Datarate	-	-	115.2	kbps	

Note 1: Current consumption measured at power supply level of 3.3 V.

Note 2: All RF parameters are measured with Input/output (pin 2) connected to 50 Ω impedance signal source or load.

TYPICAL CONNECTION DIAGRAM

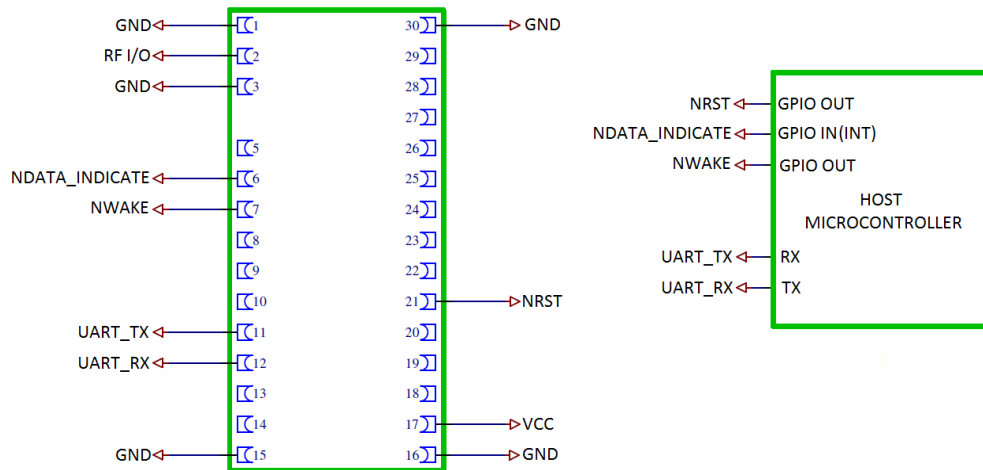

NOTES:

NRST pin connection is optional but recommended.

NDATA_INDICATE pin connection is optional but it's mandatory for low power designs where host microcontroller is in sleep state and module 32001345M activates NDATA_INDICATE pin to wake host microcontroller.

TYPICAL CHARACTERISTICS (*)

Note: All RF parameters measured with input (pin 3) connected to a 50-Ω impedance signal source or load.

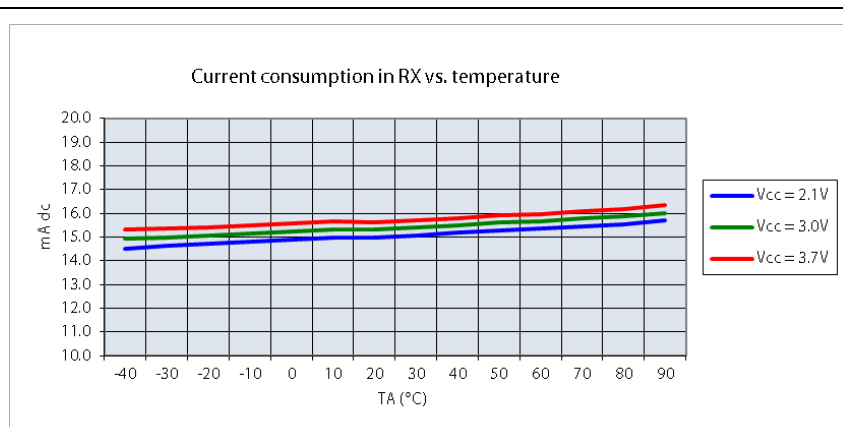
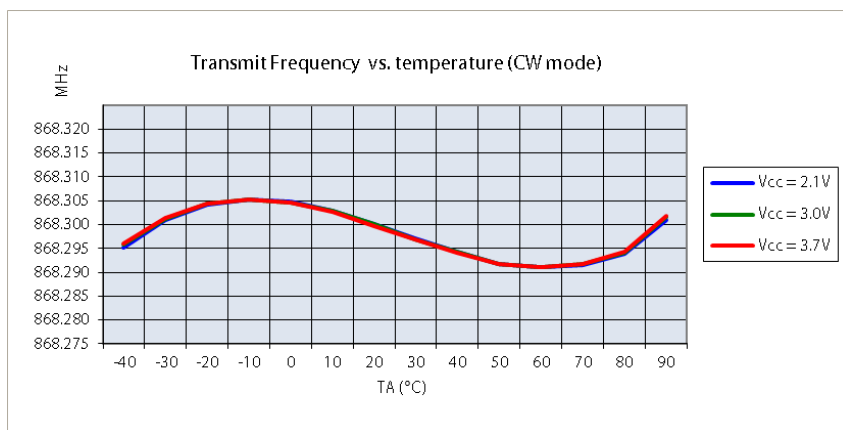
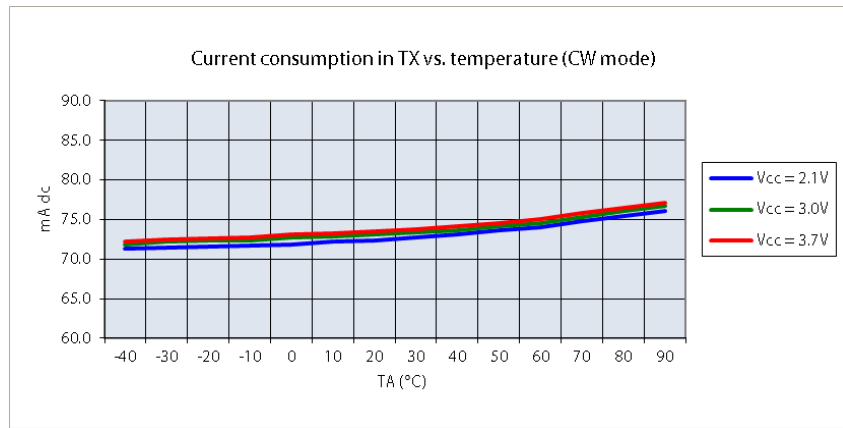
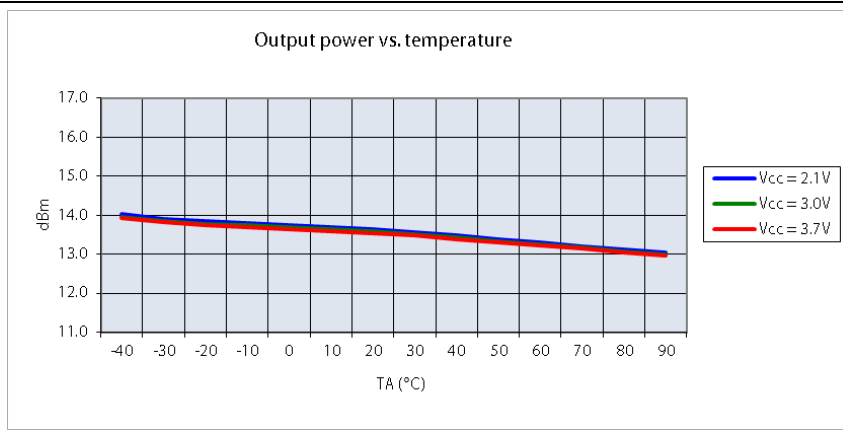

PROCESS INFORMATION

DELIVERY

32001345M modules are delivered in tape/reel packaging of 250 units.

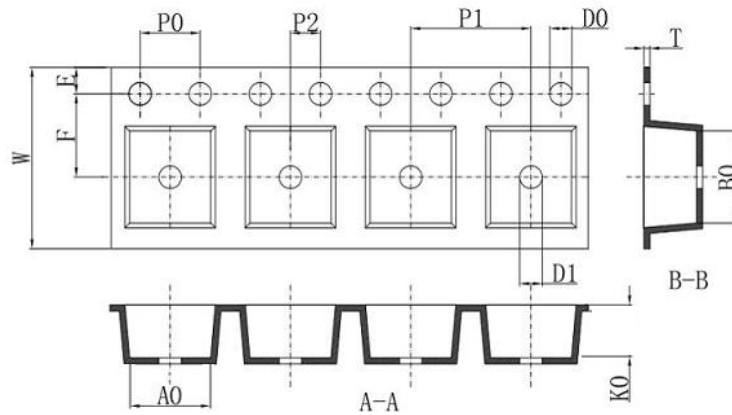

Dimensions are:

- W = 44 mm
- P = 20 mm
- T = 0.35 mm
- Ao = 16 mm
- Bo = 26.5 mm
- Ko = 3.6 mm
- D0 = 1.5 mm
- D1 = 1.5 mm

STORAGE AND HANDLING

Moisture Sensitivity Level (MSL)

The Moisture Sensitivity Level (MSL) relates to the packaging and handling precautions for devices that are sensitive to moisture-induced stress. The MSL standard is IPC/JEDEC J-STD-020 and can be downloaded from www.jedec.org. Following table summarizes the dry pack requirements for different MSL levels in the IPC/JEDEC specification.

Dry Pack Requirement

MSL LEVEL	Dry Pack Requirement
1	Optional
2	Required
3	Required
4	Required

According to IPC/JEDEC specification J-STD-020, if a device passes MSL level 1, it is classified as not moisture sensitive and does not require dry pack. If a device fails level 1 but passes a higher level, it is classified as moisture sensitive and must be dry packed in accordance with J-STD-033.

The 32001345M is qualified for MSL level = 3.

Dry Bag

Products with an MSL level of 2 or above are shipped dry packed in a Moisture Barrier Bag (MBB). Carrier materials such as trays, tubes, reels, etc., that are placed in the MBB can affect the moisture level within the dry bag. The effect of these materials is compensated by adding additional desiccant in the MBB to ensure the shelf life of the SMT packages.

IPC/JEDEC specifications require that MSD sensitive devices be packaged together with a Humidity Indicator Card (HIC) and desiccant to absorb humidity. If no moisture has been absorbed, the three fields

Mipot S.p.A. reserves the right to modify the specifications without notice Cormons, August 27th, 2019

in the HIC indicate blue color.

Storage and floor life

The calculated shelf life for dry packed SMT packages is a minimum of 12 months from the bag seal date, when stored in a non-condensing atmospheric environment of <40°C/90% RH. Following table lists floor life for different MSL levels in the IPC/JDEC specification.

Floor life	
MSL level	Floor life (out of bag) at factory ambient ≤ 30 °C / 60 % RH or as stated
1	Unlimited at ≤ 30 °C / 85 % RH
2	1 year
2a	4 weeks
3	168 hours
4	72 hours

The parts must be processed and soldered within the time specified for the MSL level. If this time is exceeded, or the humidity indicator card in the sealed package indicates that they have been exposed to moisture, the devices need to be pre-baked before the reflow solder process.

Drying

Both encapsulate and substrate materials absorb moisture. IPC/JEDEC specification J-STD-020 must be observed to prevent cracking and delamination associated with the “popcorn” effect during reflow soldering. The popcorn effect can be described as miniature explosions of evaporating moisture. Baking before processing is required in the following cases:

- Humidity indicator card: At least one circular indicator is no longer blue
- Floor life or environmental requirements after opening the seal have been exceeded, e.g. exposure to excessive seasonal humidity.
-

Refer to Section 4 of IPC/JEDEC J-STD-033 for recommended baking procedures. Table 4-1 of the specification lists the required bake times and conditions for drying.

Following table provides a summary of specified recommendations:

Bake Time							
Package Body	MSL Level	Bake @ 125 °C		Bake @ 90 °C and ≤ 5% RH		Bake @ 40 °C and ≤ 5% RH	
		Exceeding Floor Life by > 72 h	Exceeding Floor Life by ≤ 72 h	Exceeding Floor Life by >72 h	Exceeding Floor Life by ≤ 72 h	Exceeding Floor Life by > 72 h	Exceeding Floor Life by ≤ 72 h
Thickness ≤ 1.4 mm	2	5 hours	3 hours	17 hours	11 hours	8 days	5 days
	2a	7 hours	5 hours	23 hours	13 hours	9 days	7 days
	3	9 hours	7 hours	33 hours	23 hours	13 days	9 days
	4	11 hours	7 hours	37 hours	23 hours	15 days	9 days
	5	12 hours	7 hours	41 hours	24 hours	17 days	10 days
	5a	16 hours	10 hours	54 hours	24 hours	22 days	10 days
Thickness >1.4 mm ≤ 2.0 mm	2	18 hours	15 hours	63 hours	2 days	25 days	20 days
	2a	21 hours	16 hours	3 days	2 days	29 days	22 days
	3	27 hours	17 hours	4 days	2 days	37 days	23 days
	4	34 hours	20 hours	5 days	3 days	47 days	28 days
	5	40 hours	25 hours	6 days	4 days	57 days	35 days
	5a	48 hours	40 hours	8 days	6 days	79 days	56 days
Thickness >2.0 mm ≤ 4.5 mm	2	48 hours	48 hours	10 days	7 days	79 days	67 days
	2a	48 hours	48 hours	10 days	7 days	79 days	67 days
	3	48 hours	48 hours	10 days	8 days	79 days	67 days
	4	48 hours	48 hours	10 days	10 days	79 days	67 days

Mipot S.p.A. reserves the right to modify the specifications without notice Cormons, August 27th, 2019

	5	48 hours	48 hours	10 days	10 days	79 days	67 days
	5a	48 hours	48 hours	10 days	10 days	79 days	67 days

Packages of sensitive components in **32001345M** have a thickness ≤ 1.4 mm.

- **Do not attempt to bake modules at temperatures higher than 60 °C while contained in tape and rolled up in reels. If baking at higher temperature is required, remove modules from packaging and place them individually onto oven tray.**
- **Oxidation Risk: Baking SMT packages may cause oxidation and/or intermetallic growth of the terminations, which if excessive can result in solderability problems during board assembly. The temperature and time for baking SMT packages are therefore limited by solderability considerations. The cumulative bake time at a temperature greater than 90 °C and up to 125 °C shall not exceed 96 hours. If the bake temperature is not greater than 90 °C, there is no limit on bake time. Bake temperatures higher than 125 °C are not allowed.**

SOLDERING INFORMATION

Soldering pad pattern

The finished surface on the printed circuit board pads should be made of Nickel/Gold. The recommended soldering pad layout on the host board for the 32001345M is shown in the diagram below (purple lines):

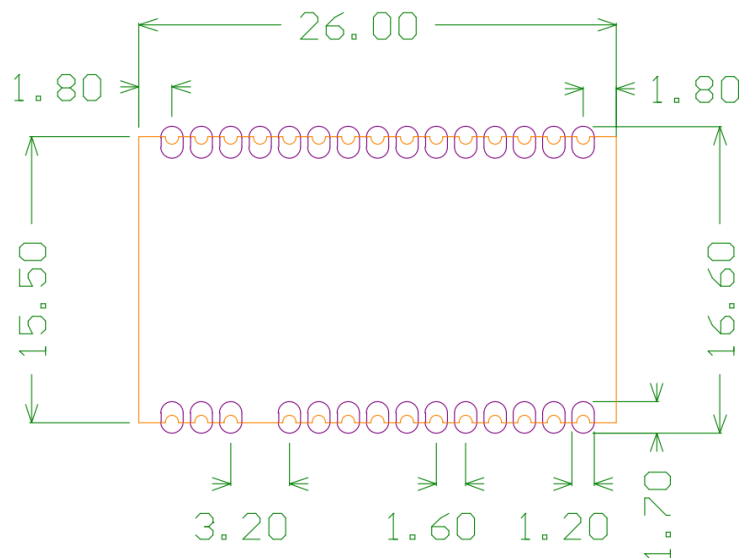

All dimensions in mm

Neither via-holes nor wires are allowed on the PCB upper layer in area occupied by the module.

Solder Paste

32001345M module is designed for surface mounting using half-moon solder joints (see diagram below). For proper module assembly, solder paste must be printed on the target surface of the host board. The suggested solder paste height should be within 150 μ m and 180 μ m.

The following diagram shows mounting characteristics for Module integration on host PCB:

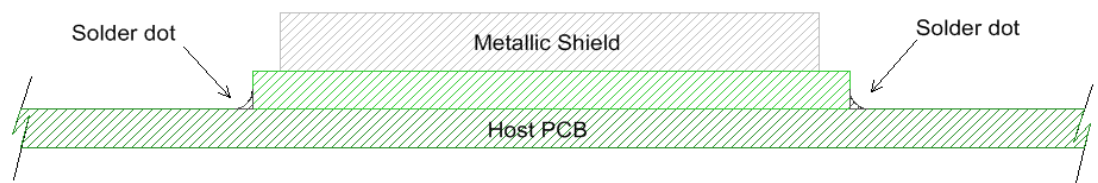

Placement

The 32001345M module can be automatically placed on host boards by pick&place machines like any integrated circuit.

Soldering Profile (RoHS Process)

It must be noted that 32001345M module should not be allowed to be hanging upside down during the reflow operation. This means that the module has to be assembled on the side of the printed circuit board that is soldered last.

The recommendation for lead-free solder reflow in IPC/JEDEC J-STD-020D Standard should be followed.

Profile Feature	Sn-Pb Assembly	Pb-Free Assembly
Average Ramp-UP Rate (Ts max to Tp)	3 °C/s max	3 °C/s max
Preheat -Temperature Min (Ts min) -Temperature Max (Ts max) -Time (ts min to ts max)	100 °C 179 °C 80-135 s	130 °C 217 °C 80-135 s
Time maintained above: -Temperature (TL) -Time (tL)	183 °C 30-90 s	220 °C 30-90 s
Peak/Classification Temperature (Tp)	Max. Peak Temp. 220 °C	Max. Peak Temp. 250 °C
Time within 5 °C of actual Peak Temperature (tp)	10-15 s	10-15 s
Ramp-Down Rate	4 °C/s max	4 °C/s max
Time 25 °C to Peak Temperature	6 minutes max	8 minutes max

Note: All temperatures refer to topside of the package, measured on the package body surface

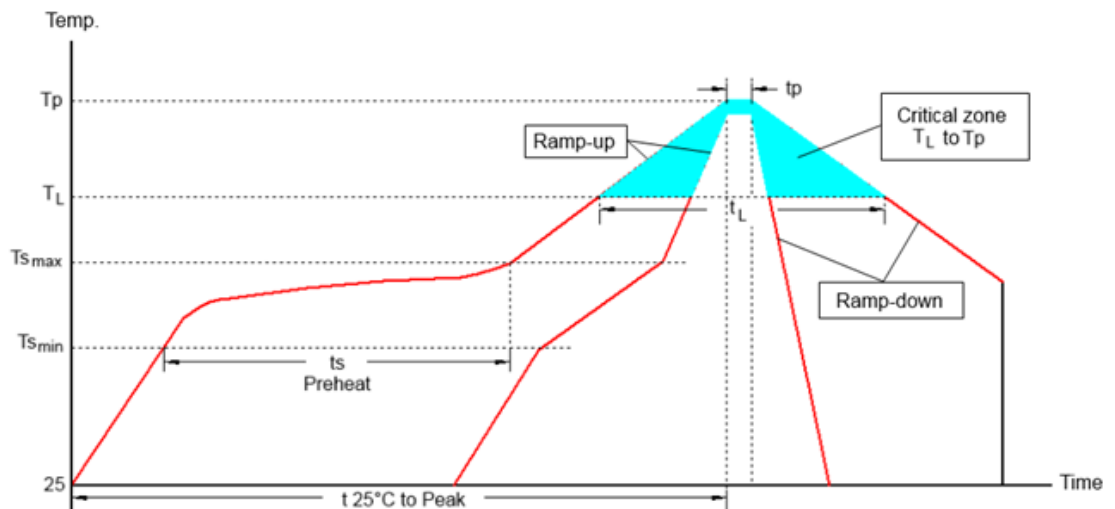

CAUTION – Please note that if the host board is submitted to a wave soldering after the reflow operation, a solder mask must be used in order to protect the 32001345M module's metal shield from being in contact with the solder wave.

REGULATORY APPROVAL

The 32001345M module is a RED Directive assessed radio module that is CE marked and has been manufactured and tested with the intention of being integrated into a final product. The 32001345M module has been tested to RED Directive 2014/53/EU Essential Requirements for Health and Safety (Article 3.1a), Electromagnetic Compatibility (EMC) (Article 3.1b), and Radio (Article 3.2).

Restrictions in terms of maximum allowed RF power or duty cycle may apply: it is responsibility of the system integrator to assure conformance of the final application to these requirements.

Note: To maintain conformance to the testing applied on the 32001345M device, the module shall be installed in accordance with the installation instructions in this data sheet and shall not be modified. When integrating a radio module into a completed product the integrator becomes the manufacturer of the final product and is therefore responsible for demonstrating compliance of the final product with the essential requirements of the RED Directive.

REVISION HISTORY

Revision	Date	Description
0.1	11-09-2018	Release
0.2	16-10-2018	Minor typo corrections
1.0	27-08-2019	Final release