

LoRaWAN 915 MHz BAND TRX MODULE

Product Code: **32001409**



PRODUCT SUMMARY:

The 32001409 is a transceiver operating in the 902-928 MHz SRD Band optimized for **very long range, low consumption applications**, suitable for **LPWA networks**. Based on **LoRa™ RF Technology** and **LoRaWAN protocol** it provides ultra-long range spread spectrum communication and high interference immunity.

Thanks to its **small LCC form factor** (15.5 x 26 mm only) and its **low current consumption**, this module allows the implementation of highly integrated low power (battery operated) solutions for Internet of Things (IoT) applications, security systems, sensor networks, metering, smart buildings, agriculture, supply chain.

This pre-certified solution allows easy integration into final application **reducing development time, costs and time-to-market**.

The embedded stack is compliant with **LoRaWAN Class A and C** specification by Lora Alliance.

Module can be configured via UART interface.

The module meets all the requirements in the **industrial temperature range -40/+85°C**.

The module is compliant according to FCC Part 15.212 Modular Transmitter Statement about FCC.

Compliant with **ReACH** and **ROHS** directives.



RF
WIRELESS

1. MECHANICAL CHARACTERISTICS

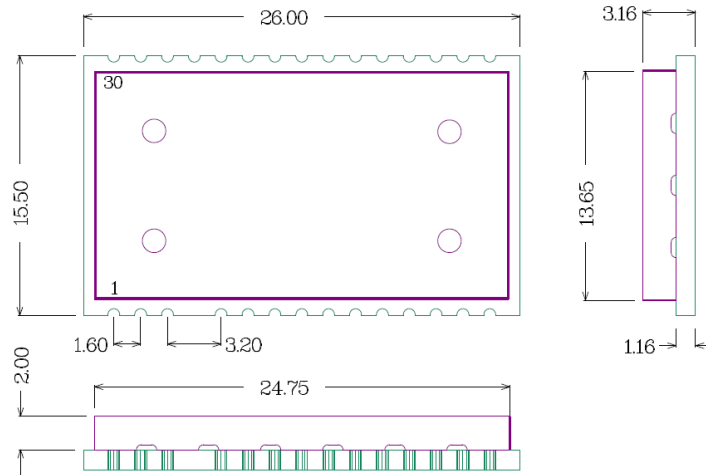

ALL DIMENSIONS ARE IN MILLIMETERS
GENERAL TOLERANCE +/-0.1MM

2. PIN DESCRIPTION

Pin	Name	Pin type	Description	Notes
1	GND	Supply	Ground (0V)	
2	RF I/O	A IN/OUT	Tx: output RF Rx: input RF	Note 3
3	GND	Supply	Ground (0V)	
5	NU	NC	Not Used Pin – do not connect	
6	NDATA_INDICATE	D OUT	Data Indicate Pin	
7	NWAKE	D IN	Wake-up Pin	

Mipot S.p.A. reserves the right to modify the specifications without notice

8	NU	NC	Not Used Pin – do not connect
9	NU	NC	Not Used Pin – do not connect
10	NU	NC	Not Used Pin – do not connect
11	UART TX	D OUT	UART TX Pin
12	UART RX	D IN	UART RX Pin
13	NU	NC	Not Used Pin – do not connect
14	NU	NC	Not Used Pin – do not connect
15	GND	Supply	Ground (0V)
16	GND	Supply	Ground (0V)
17	Vcc	Supply	Power supply
18	SWDAT	NC	Reserved for programming – do not connect
19	SWCLK	NC	Reserved for programming – do not connect
20	SWV	NC	Reserved for programming – do not connect
21	NRST	D IN	Reset. Input Pull-Up
22	NU	NC	Not Used Pin – do not connect
23	NU	NC	Not Used Pin – do not connect
24	NU	NC	Not Used Pin – do not connect
25	NU	NC	Not Used Pin – do not connect
26	NU	NC	Not Used Pin – do not connect
27	NU	NC	Not Used Pin – do not connect
28	NU	NC	Not Used Pin – do not connect
29	NU	NC	Not Used Pin – do not connect
30	GND	Supply	Ground (0V)

3. ABS. MAX. RATINGS

Transceiver Power Supply +Vcc (pin 15)	0 ÷ + 3.8V
Max. Voltage allowed on input pins	+ Vcc+0.3V
Storage Temperature (excl. package)	- 40 ÷ + 85° C
Storage Temperature (incl. package)	- 10 ÷ + 65° C
Operating Temperature	- 40 ÷ + 85° C
Radio Frequency Input, pin 2:	+10 dBm

4. ELECTRICAL CHARACTERISTICS AT +25°C TEMPERATURE

Parameter	Min.	Typ.	Max.	Unit	Notes	
Supply Voltage (Vcc)	2.4	3.3	3.7	Volt		
Current consumption	Tx mode	-	118	-	mA	Note 1
	Rx mode	-	14	-	mA	
	Sleep	-	1.3	-	µA	
Operating frequency range	902	-	928	MHz		
Tx frequency accuracy	-	±25	-	kHz		
Sensitivity	-	-	-137	dBm	Note 2	
Output Power (on 50 Ohm load)	-	+ 18	-	dBm		
Modulation		LoRa				
UART Interface Datarate	-	115.2	115.2	kbps		

5. TYPICAL CONNECTION DIAGRAM

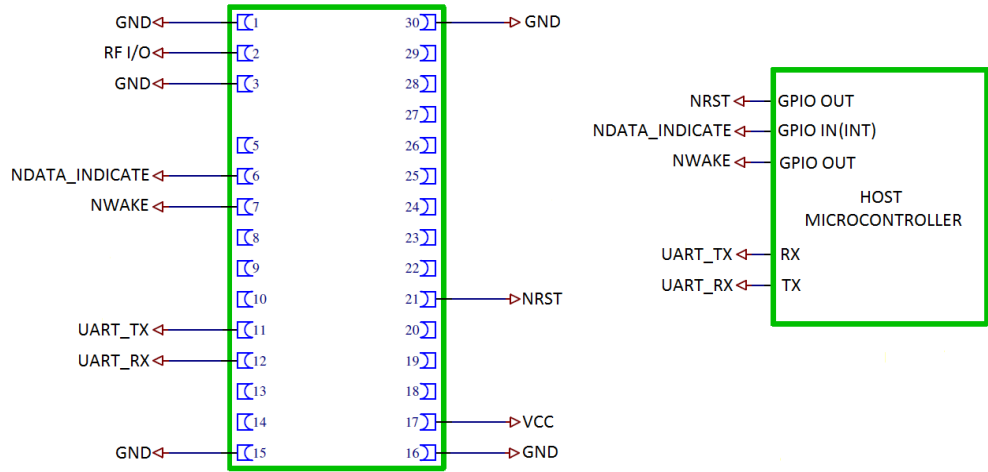

NOTES:

NRST pin connection is optional but recommended.

NDATA_INDICATE pin connection is optional but it's mandatory for low power designs where host microcontroller is in sleep state and module 32001409 activates NDATA_INDICATE pin to wake host microcontroller.

6. TYPICAL CHARACTERISTICS

RF WIRELESS

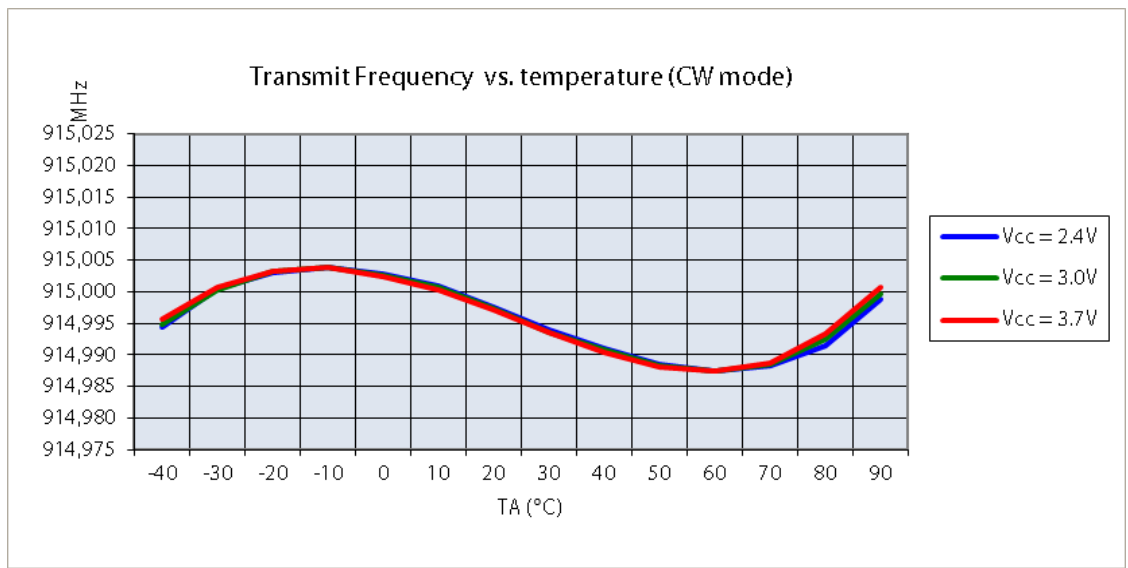
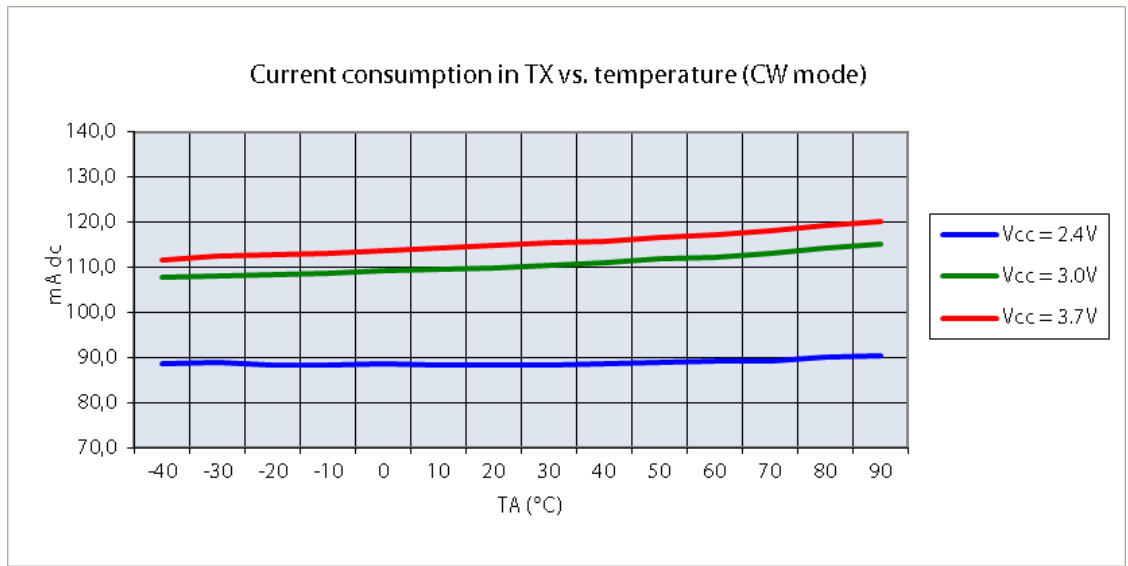
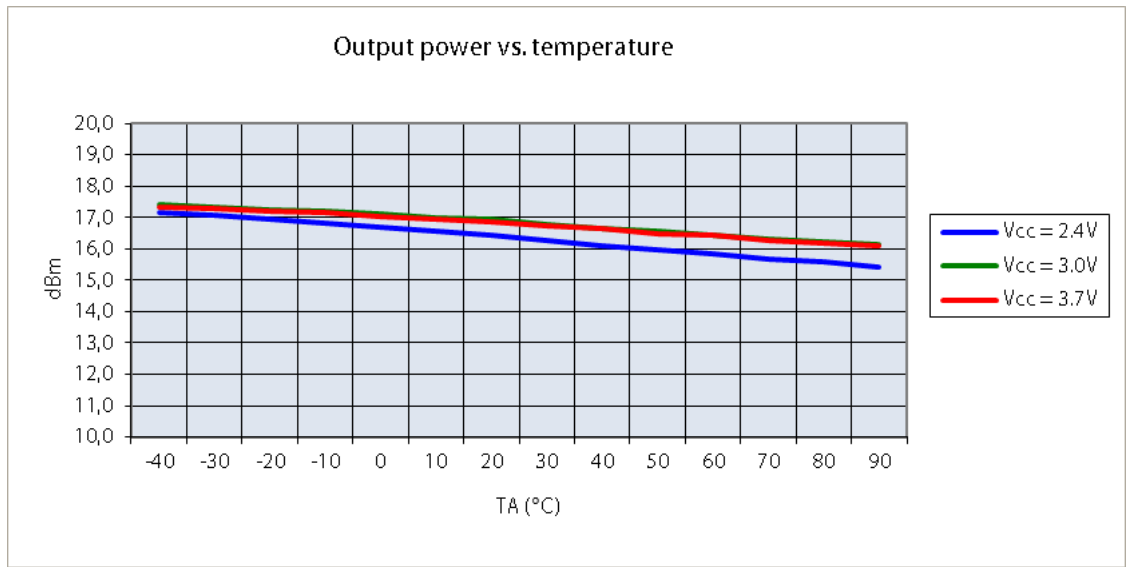

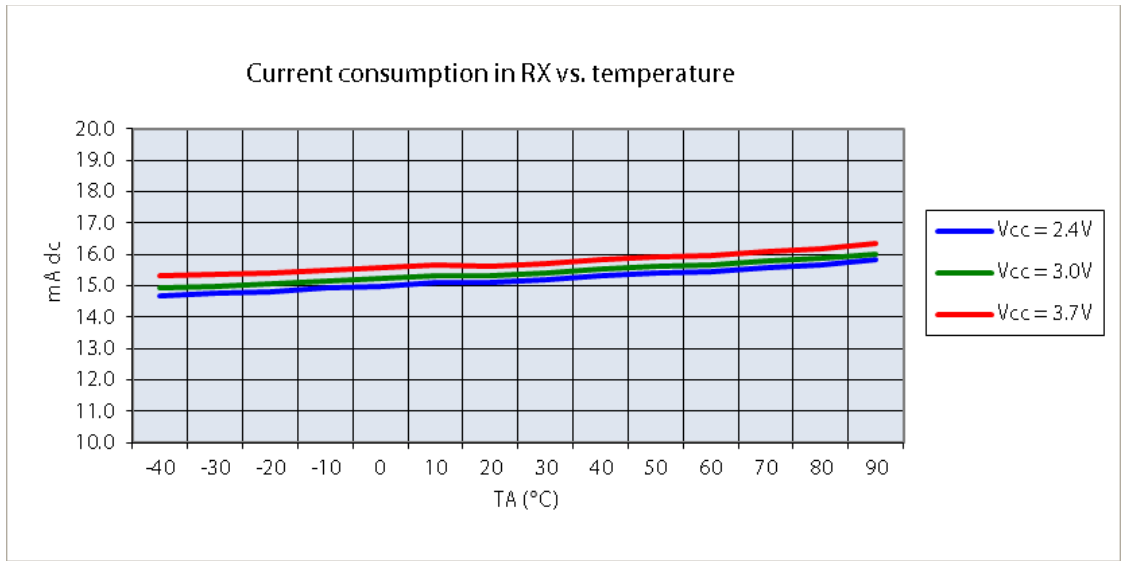
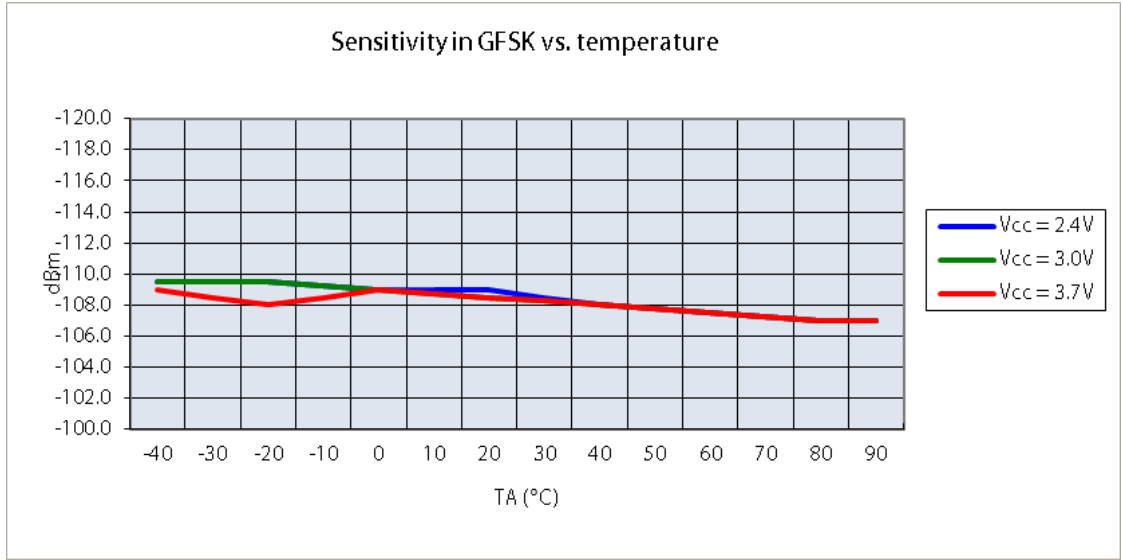

Note 1: Current consumption measured at power supply level of +3.3V.

Note 2: Sensitivity measured with GFSK modulated signal, PRBS code, 38.4 kbaud, result at BER equal or less than 10⁻².

Note 3: All RF parameters are measured with Input/output (pin 2) connected to 50 Ohm impedance signal source or load.

7. PROCESS INFORMATION

7.1. Delivery

32001409 modules are delivered in tape/reel packaging including 250 units.

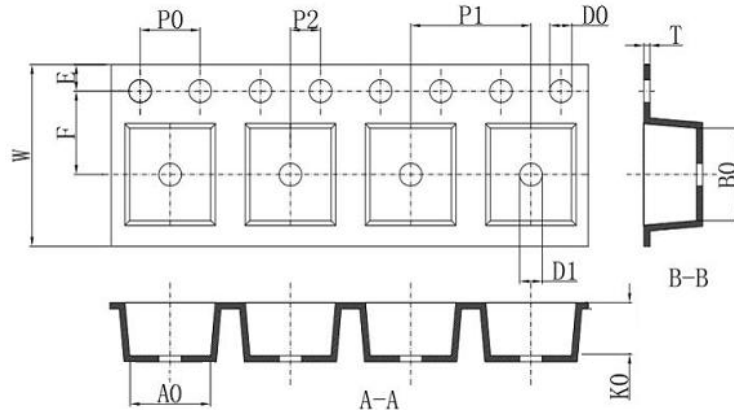

Dimensions are:

W = 44 mm

P = 20 mm

T = 0.35 mm

Ao = 16 mm

Bo = 26.5 mm

Ko = 3.6 mm

D0 = 1.5 mm

D1 = 1.5 mm

7.2. STORAGE AND HANDLING

7.2.1. Moisture Sensitivity Level (MSL)

The Moisture Sensitivity Level (MSL) relates to the packaging and handling precautions for devices that are sensitive to moisture-induced stress. The MSL standard is IPC/JEDEC J-STD-020 and can be downloaded from www.jedec.org.

Following table summarizes the dry pack requirements for different MSL levels in the IPC/JEDEC specification.

Dry Pack Requirement	
MSL LEVEL	Dry Pack Requirement
1	Optional
2	Required
3	Required
4	Required

According to IPC/JEDEC specification J-STD-020, if a device passes MSL level 1, it is classified as not moisture sensitive and does not require dry pack. If a device fails level 1 but passes a higher level, it is classified as moisture sensitive and must be dry packed in accordance with J-STD-033.

The 32001409 is qualified for MSL level = 3.

7.2.2. Dry Bag

Products with an MSL level of 2 or above are shipped dry packed in a Moisture Barrier Bag (MBB). Carrier materials such as trays, tubes, reels, etc., that are placed in the MBB can affect the moisture level within the dry bag. The effect of these materials is compensated by adding additional desiccant in the MBB to ensure the shelf life of the SMT packages.

Mipot S.p.A. reserves the right to modify the specifications without notice

IPC/JEDEC specifications require that MSD sensitive devices be packaged together with a Humidity Indicator Card (HIC) and desiccant to absorb humidity. If no moisture has been absorbed, the three fields in the HIC indicate blue color.

7.2.3. Storage and floor life

The calculated shelf life for dry packed SMT packages is a minimum of 12 months from the bag seal date, when stored in a non-condensing atmospheric environment of <40°C/90% RH. Following table lists floor life for different MSL levels in the IPC/JDEC specification.

Floor life	
MSL level	Floor life (out of bag) at factory ambient ≤30°C/60% RH or as stated
1	Unlimited at ≤30°C/85% RH
2	1 year
2a	4 weeks
3	168 hours
4	72 hours

The parts must be processed and soldered within the time specified for the MSL level. If this time is exceeded, or the humidity indicator card in the sealed package indicates that they have been exposed to moisture, the devices need to be pre-baked before the reflow solder process.

7.2.4. Drying

Both encapsulate and substrate materials absorb moisture. IPC/JEDEC specification J-STD-020 must be observed to prevent cracking and delamination associated with the “popcorn” effect during reflow soldering. The popcorn effect can be described as miniature explosions of evaporating moisture. Baking before processing is required in the following cases:

- Humidity indicator card: At least one circular indicator is no longer blue
- Floor life or environmental requirements after opening the seal have been exceeded, e.g. exposure to excessive seasonal humidity.

Refer to Section 4 of IPC/JEDEC J-STD-033 for recommended baking procedures. Table 4-1 of the specification lists the required bake times and conditions for drying.

Following table provides a summary of specified recommendations:

Bake Time							
Package Body	MSL Level	Bake @ 125°C		Bake @ 90°C ≤ 5% RH		Bake @ 40°C ≤ 5% RH	
		Exceeding Floor Life by > 72 h	Exceeding Floor Life by ≤ 72 h	Exceeding Floor Life by >72 h	Exceeding Floor Life by ≤ 72 h	Exceeding Floor Life by > 72 h	Exceeding Floor Life by ≤ 72 h
Thickness ≤ 1.4 mm	2	5 hours	3 hours	17 hours	11 hours	8 days	5 days
	2a	7 hours	5 hours	23 hours	13 hours	9 days	7 days
	3	9 hours	7 hours	33 hours	23 hours	13 days	9 days
	4	11 hours	7 hours	37 hours	23 hours	15 days	9 days
	5	12 hours	7 hours	41 hours	24 hours	17 days	10 days
	5a	16 hours	10 hours	54 hours	24 hours	22 days	10 days
Thickness ≥ 1.4 mm ≤ 2.0 mm	2	18 hours	15 hours	63 hours	2 days	25 days	20 days
	2a	21 hours	16 hours	3 days	2 days	29 days	22 days
	3	27 hours	17 hours	4 days	2 days	37 days	23 days
	4	34 hours	20 hours	5 days	3 days	47 days	28 days
	5	40 hours	25 hours	6 days	4 days	57 days	35 days

Mipot S.p.A. reserves the right to modify the specifications without notice

	5a	48 hours	40 hours	8 days	6 days	79 days	56 days
Thickness >2.0 mm ≤ 4.5 mm	2	48 hours	48 hours	10 days	7 days	79 days	67 days
	2a	48 hours	48 hours	10 days	7 days	79 days	67 days
	3	48 hours	48 hours	10 days	8 days	79 days	67 days
	4	48 hours	48 hours	10 days	10 days	79 days	67 days
	5	48 hours	48 hours	10 days	10 days	79 days	67 days
	5a	48 hours	48 hours	10 days	10 days	79 days	67 days

Packages of sensitive components in **32001409** have a thickness **≤1.4 mm**.

- **Do not attempt to bake modules at temperatures higher than 60°C while contained in tape and rolled up in reels. If baking at higher temperature is required, remove modules from packaging and place them individually onto oven tray.**
- **Oxidation Risk:** Baking SMT packages may cause oxidation and/or intermetallic growth of the terminations, which if excessive can result in solderability problems during board assembly. The temperature and time for baking SMT packages are therefore limited by solderability considerations. The cumulative bake time at a temperature greater than 90°C and up to 125°C shall not exceed 96 hours. If the bake temperature is not greater than 90°C, there is no limit on bake time. Bake temperatures higher than 125°C are not allowed.

7.3. SOLDERING INFORMATION

7.3.1. Soldering pad pattern

The finished surface on the printed circuit board pads should be made of Nickel/Gold.

The recommended soldering pad layout on the host board for the 32001409 is shown in the diagram below (purple lines):

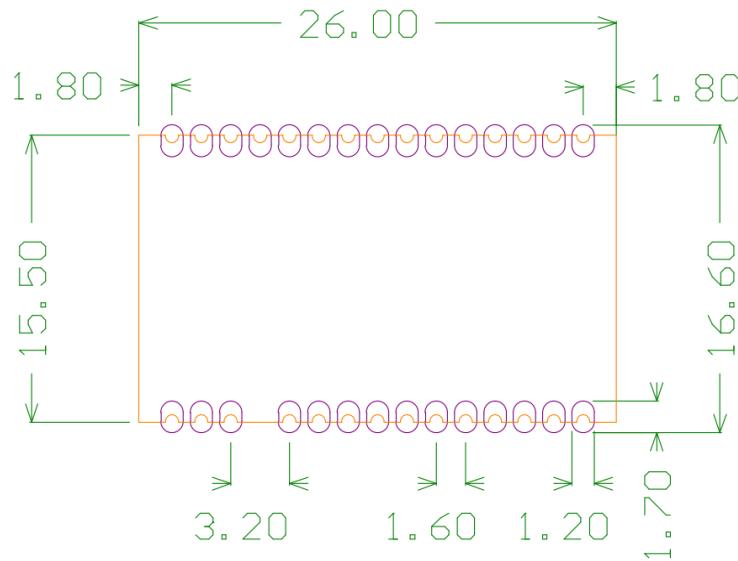

All dimensions in mm

Neither via-holes nor wires are allowed on the PCB upper layer in area occupied by the module.

7.3.2. Solder Paste

32001409 module is designed for surface mounting using half-moon solder joints (see diagram below). For proper module assembly, solder paste must be printed on the target surface of the host board. The suggested solder paste height should be within 150 µm and 180 µm .

The following diagram shows mounting characteristics for Module integration on host PCB:

Mipot S.p.A. reserves the right to modify the specifications without notice

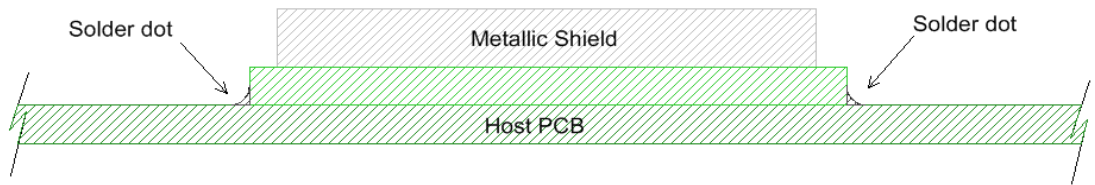

7.3.3. Placement

The 32001409 module can be automatically placed on host boards by pick&place machines like any integrated circuit.

7.3.4. Soldering Profile (RoHS Process)

It must be noted that 32001409 module should not be allowed to be hanging upside down during the reflow operation. This means that the module has to be assembled on the side of the printed circuit board that is soldered last.

The recommendation for lead-free solder reflow in IPC/JEDEC J-STD-020D Standard should be followed.

Profile Feature	Sn-Pb Assembly	Pb-Free Assembly
Average Ramp-UP Rate (Ts max to Tp)	3°C/second max	3°C/second max
Preheat		
-Temperature Min (Ts min)	100°C	130°C
-Temperature Max (Ts max)	179°C	217°C
-Time (ts min to ts max)	80-135 seconds	80-135 seconds
Time maintained above:		
-Temperature (TL)	183°C	220°C
-Time (tL)	30-90 seconds	30-90 seconds
Peak/Classification Temperature (Tp)	max. Peak Temp. 220°C	max. Peak Temp. 250°C
Time within 5°C of actual Peak Temperature (tp)	10-15 seconds	10-15 seconds
Ramp-Down Rate	4°C/second max	4°C/second max
Time 25°C to Peak Temperature	6 minutes max	8 minutes max

Note: All temperatures refer to topside of the package, measured on the package body surface

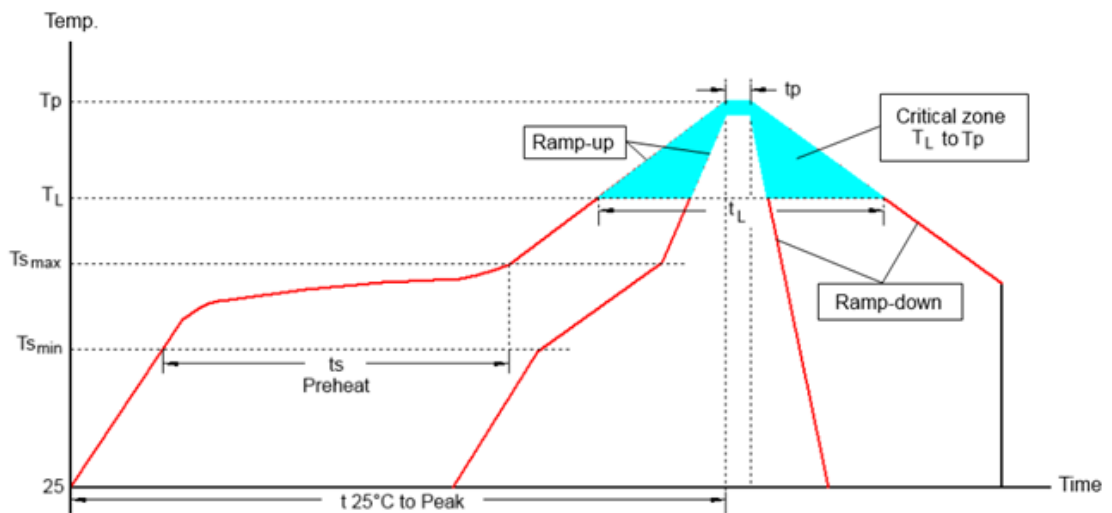

CAUTION – Please note that if the host board is submitted to a wave soldering after the reflow operation, a solder mask must be used in order to protect the 32001409 module’s metal shield from being in contact with the solder wave.

Mipot S.p.A. reserves the right to modify the specifications without notice

8. REGULATORY APPROVAL

The Changes or modifications not expressly approved by the party responsible for compliance could void the user's authority to operate the equipment.

This device complies with part 15 of the FCC Rules. Operation is subject to the following two conditions: (1) This device may not cause harmful interference, and (2) this device must accept any interference received, including interference that may cause undesired operation.

8.1. Class B device notice

Note: This equipment has been tested and found to comply with the limits for a Class B digital device, pursuant to part 15 of the FCC Rules. These limits are designed to provide reasonable protection against harmful interference in a residential installation. This equipment generates, uses and can radiate radio frequency energy and, if not installed and used in accordance with the instructions, may cause harmful interference to radio communications. However, there is no guarantee that interference will not occur in a particular installation. If this equipment does cause harmful interference to radio or television reception, which can be determined by turning the equipment off and on, the user is encouraged to try to correct the interference by one or more of the following measures:

- Reorient or relocate the receiving antenna.
- Increase the separation between the equipment and receiver.
- Connect the equipment into an outlet on a circuit different from that to which the receiver is connected.
- Consult the dealer or an experienced radio/TV technician for help.

8.2. RF exposure safety

This product is a radio transmitter and receiver.

It is designed not to exceed the emission limits for exposure to radio frequency (RF) energy set by the Federal Communications Commission.

The antenna must be installed and operated with minimum distance of **XX** cm between the radiator and your body.

This transmitter must not be co-located or operating in conjunction with any other antenna or transmitter.

8.3. Permitted Antenna

This radio transmitter has been approved by FCC to operate with the antenna types listed below with the maximum permissible gain indicated. Antenna types not included in this list, having a gain greater than the maximum gain indicated for that type, are strictly prohibited for use with this device.

Type	Max Gain
Quarter-wave monopole, GSM 900/1800	< 2 dBi

8.4. Labelling Requirements for the Host Device

The host device shall be properly labelled to identify the modules within the host device. The certification label of the module shall be clearly visible at all times when installed in the host device, otherwise the host device must be labelled to display the IC of the module, preceded by the words "Contains transmitter module", or the word "Contains", or similar wording expressing the same meaning, as follows:

Contains FCC ID: 2AQJP-32001409

9. GLOSSARY

ABP = Activation by personalization
 OTAA = Over The Air Activation
 SN = Serial Number
 FW = Firmware
 EUI = Extended Unique Identifier
 LSB = Least significant byte
 MSB = Most significant byte
 Cks = Checksum

10. REFERENCES

- [1] LoRaWAN Specification V1.0.2
- [2] Sx1272 Datasheet

11. REVISION HISTORY

Revision	Date	Description
0.1	30-04-2018	Preliminary
0.2	31-07-2018	Added Regulatory section
1.0	10-10-2018	Change on FCC statement compliance